



空间隔断及存储系统
Storage space partition system

Writing and nailing system

A system full of possibilities

Improve the work inspiration, must be full of energetic elements in the space, such as interesting objects, exaggerated design, or books of improve mental state, etc. By freedom, let people to get rid of the trouble, to reach the spirit of absolute freedom. This interesting vitality and artistic influence each other and penetration, let a person get big play to creativity, imagination.

提升工作灵感，一定是空间中富有生命力的元素，比如有趣的物件，夸张的设计，或是提升精神境界的书籍等。通过崇尚自由的事物，让人们摆脱烦恼，达到精神的绝对自由。这种有趣的生命力与艺术互相影响和渗透，让人的创造力、想象力得到大大的发挥。



Application show | 应用展示



01 都市书架
City Bookshlef



02 模块书架
Modular Bookshelf

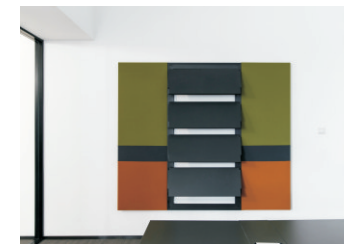

03 挂墙书架
Case



04 应用指南
Leitfaden guide

Bookshelf system

01 City Bookshlef | 都市书架

Public space is a place to build creative thinking, the shelf promotes the construction of mind, you can stay here, enjoy a moment of peace and the movement of thought, suitable for all kinds of environment, the shelf is made of metal ,by the metal coating process.

公共空间是一个营造创造性思维的地方，摆放书架有利于思维的营造，你可以停留在这，享受片刻的宁静和思想的跃动，适合各种各样的环境，书架采用金属材质，通过金属涂装工艺制造而成。



Bookshelf system

01 City Bookshlef | 都市书架



Bookshelf system

01 City Bookshlef | 都市书架



Bookshelf system

01 City Bookshlef | 都市书架



Bookshelf system

01 City Bookshlef | 都市书架





Bookshelf system

01 City Bookshlef | 都市书架

Bookshelf system

01 City Bookshlef | 都市书架



Bookshelf system

01 City Bookshlef | 都市书架



Bookshelf system

02 Modular Bookshelf | 模块书架

The use of public space should meet the needs of the people, the shelf is a good choice, is conducive to the creation of the mind, modular bookshelf simple and fashion, suitable for any style of the space, has a strong practicability and decoration, the shelf is made of metal ,by the metal coating process.

公共空间的利用应当满足人群的需要，摆放书架就是个不错的选择，有利于思维的创作，模块化的书架简约时尚，适用于任何风格的空间，具有很强的实用性和装饰性，采用金属材质，通过金属涂装工艺制造而成。





Bookshelf system

02 Modular Bookshelf | 模块书架



Bookshelf system

02 Modular Bookshelf | 模块书架



Bookshelf system

02 Modular Bookshelf | 模块书架



Bookshelf system

02 Modular Bookshelf | 模块书架



Bookshelf system

03 Case | 挂墙书架



Bookshelf system

03 Case | 挂墙书架



Bookshelf system

The module 模块

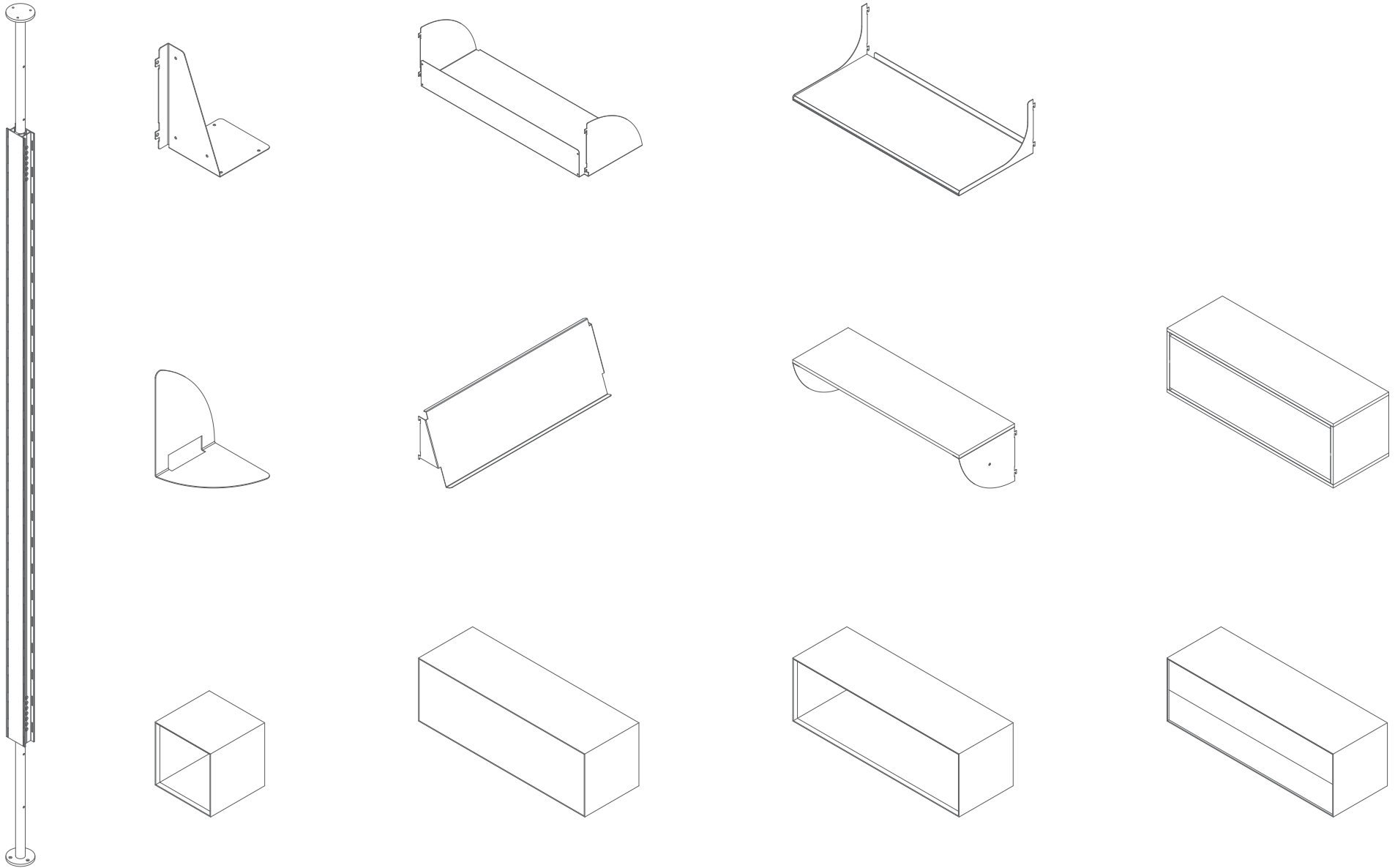

Bookshelf system

The module 模块

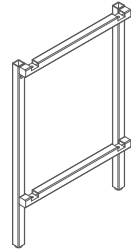
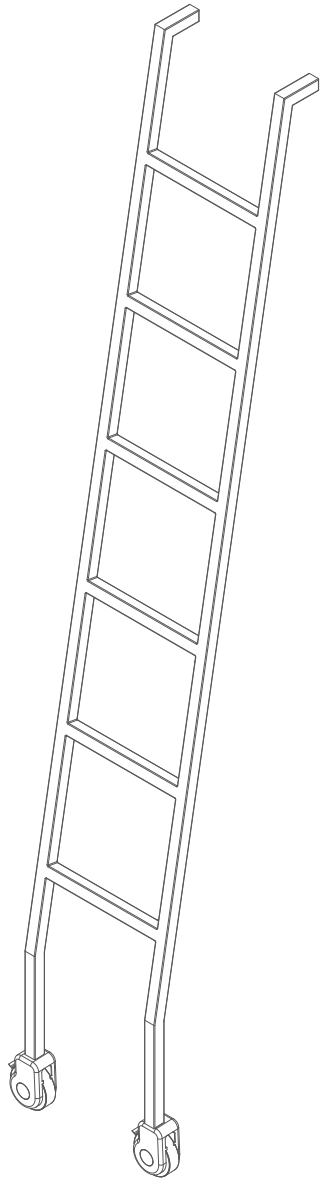

底部架子BC-DB

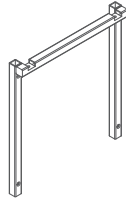

增链架子BC-MB

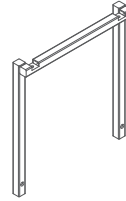

顶部架子BC-UB

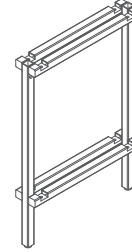

增链底部架子BC-ZDB

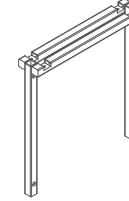

增链架子BC-MB

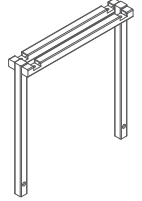

增链顶部架子BC-ZUB

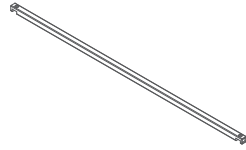

支撑杆BC-HG

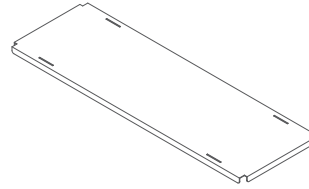

钢板BC-CB

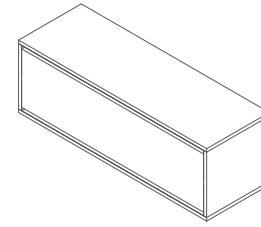

盒箱

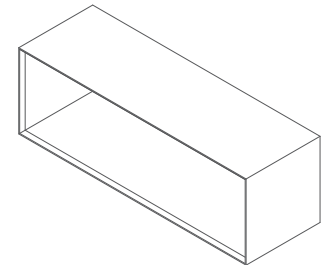
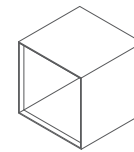
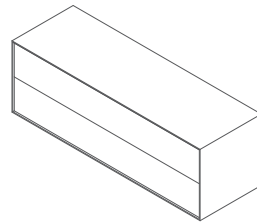
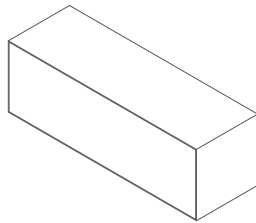

Bookshelf system

04 Installation instructions 安装说明

注意：本产品为可回收产品，可二次回收
 Note: this product is a recycled product, can the secondary recover

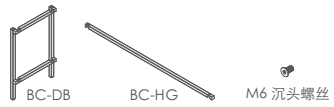

1. 先找出以上三种配件
 1. To find out the above three parts

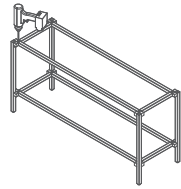

2. 用螺丝和电批通过M6沉头螺丝将BC-DB和BC-HG连接固定
 2. Using screws and electricity screw driver passed the M6 countersunk head screws, connected the BC - DB and BC - HG and fixed

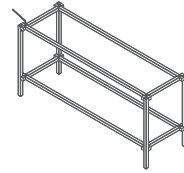

3. 通过扳手将螺丝拧紧
 3. Using the spanner tightened the screw

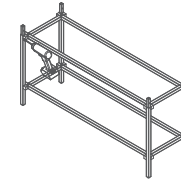

4. 用电批和M6螺丝将装好框架和BC-MZ相连 (重复步骤②拧紧)
 4. Using the Electricity screw driver and M6 screw, installed the framework and connected to BC - MZ (repeat step (2) and tighten)

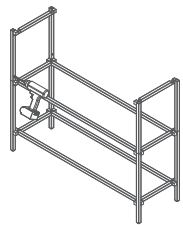

5. 用电批和M6螺丝将装好框架和BC-MB相连 (重复步骤②拧紧)
 5. Using the Electricity screw driver and M6 screw, installed the framework and connected to BC - MB(repeat step (2) and tighten)

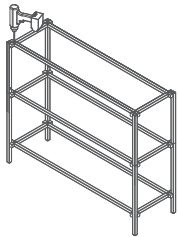

6. 用螺丝和电批通过M6沉头螺丝将现有框架和BC-HG连接固定 (重复步骤②拧紧)
 6. Using screws and electricity screw driver passed the M6 countersunk head screws, connected BC - HG and fixed

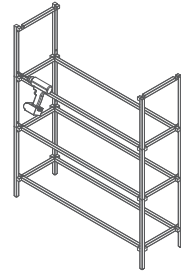

7. 用电批和M6螺丝将装好框架和BC-MB相连 (重复步骤②拧紧)
 7. Using the Electricity screw driver and M6 screw, installed the framework and connected to BC - MB(repeat step (2) and tighten)

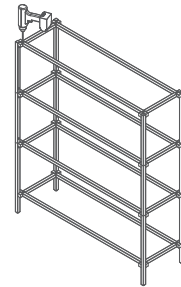

8. 用螺丝和电批通过M6沉头螺丝将现有框架和BC-HG连接固定 (重复步骤②拧紧)
 8. Using screws and electricity screw driver passed the M6 countersunk head screws, connected BC - HG and fixed

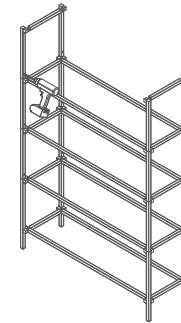

9. 用电批和M6螺丝将装好框架和BC-MB相连 (重复步骤②拧紧)
 9. Using the Electricity screw driver and M6 screw, installed the framework and connected to BC - MB(repeat step (2) and tighten)

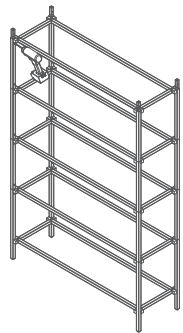

10. 用电批和M6螺丝将装好框架和BC-MZ相连 (重复步骤②拧紧)
 10. Using the Electricity screw driver and M6 screw, installed the framework and connected to BC - MZ (repeat step (2) and tighten)

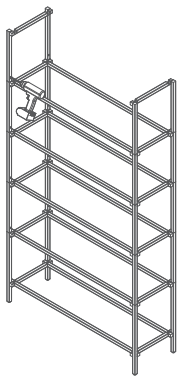

11. 用电批和M6螺丝将装好框架和BC-UB相连 (重复步骤②拧紧)
 11. Using the Electricity screw driver and M6 screw, installed the framework and connected to BC - UB(repeat step (2) and tighten)

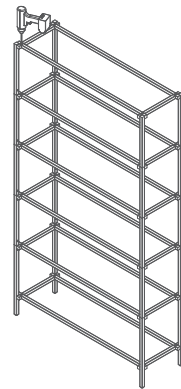

12. 用电批和M6螺丝将装好框架和BC-HG相连 (重复步骤②拧紧)
 12. Using screws and electricity screw driver passed the M6 countersunk head screws, connected BC - HG and fixed

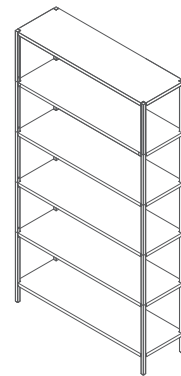

13. 把BC-CB放在装好框架上
 13. Placing the BC - CB on the installed frame

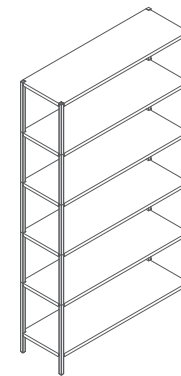

配件名称 / 编码	图示	数量
BC-CB		4
BC-HG		8
BC-DJ		4
BC-MZ		8
BC-DB		2
BC-UB		2
BC-MB		2
M6 沉头螺丝		56

DESIGN
LIGHTING
FURNITURE
SUPPLIES
ORNAMENT
TECHNOLOGY



HIQ Group Ltd

Unit 07B-09, 22/F, Kodak House 2, 39 Healthy Street East, North Point, Hong Kong

香港北角健康東街39號22樓2207B-09室

Tel – 2575 8966 Fax – 2575 8633

Email : info@hiq-group.com Website : www.hiq-group.com